

# Magnetic fields generated by piecewise rectilinear configurations

C. Udriște, V. Balan, A. Udriște

**Abstract.** The paper determines the magnetic field and its vector and scalar potentials for spatial piecewise rectilinear configurations. Several applications for configurations which generate open magnetic lines, plane angular circuits and properties of the magnetic lines and surfaces, are provided.

**M.S.C. 2010:** 53B50.

**Key words:** magnetic field; vector potential; scalar potential; polyhedral configuration.

## 1 Decomposition in elementary circuits of a piecewise rectilinear spatial configuration

For  $i = \overline{1, n}$ , let  $\gamma_i$  be a piecewise rectilinear electric circuit traversed by the current  $\bar{I}_i$  which is constant on each rectilinear part. Let  $\bar{J}_i$  be the associated versor, piecewise defined via  $\bar{J}_i = \bar{I}_i/I_i$ , where  $I_i = \|\bar{I}_i\|$ .

The circuit  $\gamma_i$  is expressed in the form

$$\gamma_i = \bigcup_{j=1}^m \gamma_{ij},$$

where  $\gamma_{ij}$  is a straight line, a semi-line or a segment in space, disposed under the condition of circuit closedness (either at finite distance, or at infinity). Let

$$\Gamma = \bigcup_{i=1}^n \gamma_i = \bigcup_{i=1}^n \bigcup_{j=1}^m \gamma_{ij}$$

be a configuration in space, union of piecewise linear electric circuits. For modelling real phenomena, we agree that a configuration in space has to satisfy the following axioms:

(A.1) - Each segment  $\gamma_{ij}$  has its edges in contact with the extremities of other segments or semi-lines  $\gamma_{kl}$ . Each semi-line  $\gamma_{ij}$  has its finite edge in contact with the edge of a segment or of a semi-line  $\gamma_{kl}$ .

(A.2) - At each knot (contact point) the second Kirchhoff law shall be satisfied, i.e., the algebraic sum of the intensities vanishes. If this won't happen, the magnetic field associated to the net doesn't admit a scalar potential  $U$ .

Assuming that these axioms are satisfied, the magnetic field associated to the configuration  $\Gamma$  will be, according to the Biot-Savart-Laplace (BSL) rule,

$$\bar{H}_\Gamma = \sum_{i=1}^n \bar{H}_{\gamma_i}, \quad \bar{H}_{\gamma_i}(M) = I_i \int_{\gamma_i} \frac{\bar{J}_i \times \overline{PM}}{PM^3} d\tau_P, \quad \forall M \in \mathbb{R}^3 \setminus \Gamma,$$

where  $P \in \gamma_i$  is the arbitrary point on the electric circuit  $\gamma_i$ , and  $\bar{H}_{\gamma_i}$  is the magnetic field generated by the electric circuit  $\gamma_i$  (modulo a multiplicative constant,  $1/4\pi$ ).

Using the additivity of the integral, we can write

$$\bar{H}_\Gamma = \sum_{i=1}^n \sum_{j=1}^m \bar{H}_{\gamma_{ij}}, \quad \bar{H}_{\gamma_{ij}}(M) = I_{ij} \int_{\gamma_{ij}} \frac{\bar{J}_{ij} \times \overline{PM}}{PM^3} d\tau_P, \quad \forall M \in \mathbb{R}^3 \setminus \Gamma,$$

where  $P \in \gamma_{ij}$  is the arbitrary point on the rectilinear segment  $\gamma_{ij}$ . We notice that  $\bar{H}_{\gamma_{ij}}$  is a proper magnetic field iff  $\gamma_{ij}$  is a straight line.

The configuration  $\Gamma$  which satisfies the axioms (A.1), (A.2) produces the same magnetic field as the one determined by the configuration

$$\tilde{\Gamma} = \bigcup_{i=1}^n \bigcup_{j=1}^m \tilde{\gamma}_{ij},$$

where  $\tilde{\gamma}_{ij}$  are electric circuits determined as follows:

a) If  $\gamma_{ij}$  is a finite segment  $\gamma_{ij} = [AB]$ , then  $\tilde{\gamma}_{ij}$  is the union

$$\tilde{\gamma}_{ij} = (A_-A) \cup \gamma_{ij} \cup [BB_+],$$

where the semi-lines  $(A_-A)$  and  $[BB_+)$  are parallel to the axis  $Ox$  and are traversed by a current of constant magnitude  $I_{ij}$ , with the sense given by the order of points (Fig.1).

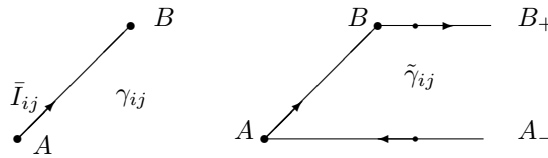

Fig. 1

b) If  $\gamma_{ij}$  is a semi-line which is oriented by the current  $\bar{I}$ , then:

b<sub>1</sub>) for  $\gamma_{ij} = [AB_+)$ , we have  $\tilde{\gamma}_{ij} = (A_-A) \cup [AB_+)$ ;

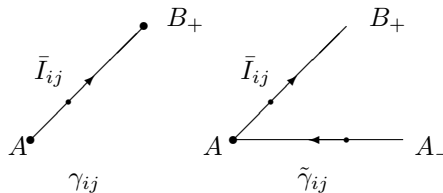

Fig. 2.1

b<sub>2</sub>) for  $\gamma_{ij} = (A_-B]$ , we have  $\tilde{\gamma}_{ij} = (A_-B] \cup [BB_+)$ ,

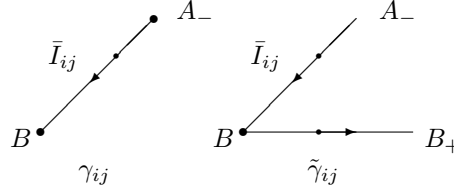

Fig. 2.2

where  $(A_-A]$  and  $[BB_+)$  are semi-lines parallel to  $Ox$ , traversed by a current of magnitude  $I_{ij}$ , with the sense given by the order of points (Fig.2.1, 2.2). c) If  $\gamma_{ij}$  is a line  $(A_-B_+)$  oriented by  $\bar{I}_{ij}$ , then  $\tilde{\gamma}_{ij} = \gamma_{ij}$ .

**Remarks.** 1) In this framework, we have the equal magnetic fields

$$\bar{H}_\Gamma(M) = \bar{H}_{\tilde{\Gamma}}(M), \forall M \in \mathbb{R}^3 \setminus \Gamma,$$

because adding the terms,

$$\bar{H}_{\tilde{\Gamma}}(M) = \sum_{i=1}^n \bar{H}_{\tilde{\gamma}_i}(M), M \in \mathbb{R}^3 \setminus \tilde{\Gamma},$$

the domain of the function  $\bar{H}_{\tilde{\Gamma}}$  is extended (by continuity) from  $\mathbb{R}^3 \setminus \tilde{\Gamma}$  to  $\mathbb{R}^3 \setminus \Gamma$ .

2) A configuration  $\tilde{\gamma}_{ij}$  of type a),  $\tilde{\gamma}_{ij} = (A_-A] \cup [AB] \cup [BB_+)$ , produces a magnetic field, which is equivalent to the one produced by a pair of angular configurations, namely

$$\hat{\gamma}_{ij} = \gamma_{ij_1} \cup \gamma_{ij_2}, \begin{cases} \gamma_{ij_1} = (A_-A] \cup [AB_0] \\ \gamma_{ij_2} = (B_0B] \cup [BB_+), \end{cases}$$

as shown in Fig.3.

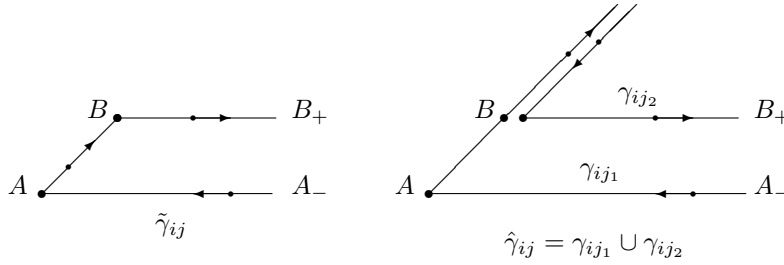

Fig. 3

3) Hence, it follows that any spatial configuration  $\Gamma$  which satisfies the postulates (A.1), (A.2) decomposes into angular configurations  $\gamma$  (called in the following, elementary angular configurations) traversed by the current  $\bar{I}$  (of intensity  $I$ , and associated vector  $\bar{J}$ ).

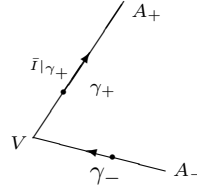

Fig. 4

Here the current  $\bar{I}|_{\gamma}$  represents a vectorfield which is tangent to the curve  $\gamma$ , which has a discontinuity at the vertex  $V$ . The mapping  $I$  is piecewise constant.

We remark that the straight line is a particular case, obtained easily as opposed semi-lines (with the angle of magnitude  $\pi$ ).

The magnetic field  $\bar{H}_{\Gamma}$  defined on  $\mathbb{R}^3 \setminus \Gamma$  by the BSL formula is irrotational ( $\text{rot } \bar{H}_{\Gamma} = \bar{0}$ ) and solenoidal ( $\text{div } \bar{H}_{\Gamma} = 0$ ). Therefore, it admits a local scalar potential  $U_{\Gamma}$ , i.e.,  $\bar{H}_{\Gamma} = \text{grad } U_{\Gamma}$  and a vector potential

$$\bar{\Phi}_{\Gamma} = \sum_{i=1}^n I_i \int_{\gamma_i} \frac{\bar{J}_i}{PM} d\tau_P,$$

i.e.,  $\bar{H}_{\Gamma} = \text{rot } \bar{\Phi}_{\Gamma}$ .

## 2 The magnetic field associated to an elementary angular spatial configuration

In the following, we shall study the magnetic field  $\bar{H}_{\gamma}$  of an elementary angular spatial configuration  $\gamma$ . Using the additivity of the Biot-Savart-Laplace formula, we shall obtain in Section 3 the magnetic field associated to an arbitrary configuration  $\Gamma$  which satisfies the axioms from Section 1.

**Notations.** For the elementary configuration  $\gamma$  from Fig.4, we shall denote

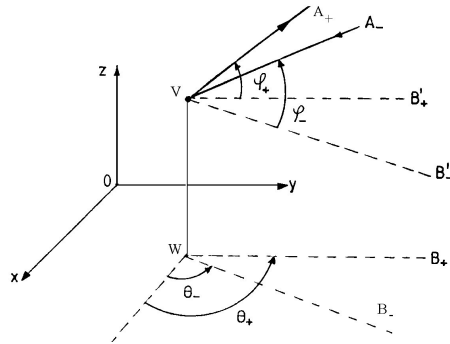

Fig. 5

$$\gamma = \gamma_- \cup \gamma_+,$$

$$\gamma_- = \Gamma(V, \theta_-, \varphi_-) = (A_- V), \quad \gamma_+ = \Gamma(V, \theta_+, \varphi_+) = [V A_+],$$

where

$$\begin{cases} \theta_- = (\widehat{Ox, \overline{WB}_-}), \theta_+ = (\widehat{Ox, \overline{WB}_+}) \in [0, 2\pi) \\ \varphi_- = (\widehat{\overline{WB}_-, \overline{VA}_-}), \varphi_+ = (\widehat{\overline{WB}_+, \overline{VA}_+}) \in [-\pi/2, \pi/2], \end{cases}$$

and  $B_+, B_-, W$  are respectively the projections of  $A_+, A_-, V$ , on  $xOy$ . We can determine these four angles, considering the following result

**Lemma 1.** *Let be the segment  $[AB]$  of extremities*

$$A = (x_A, y_A, z_A), B = (x_B, y_B, z_B), A \neq B \in \mathbb{R}^3$$

We shall use the notations

$$\begin{cases} x_\Delta = x_B - x_A, y_\Delta = y_B - y_A, z_\Delta = z_B - z_A, \\ \rho = (x_\Delta^2 + y_\Delta^2 + z_\Delta^2)^{1/2}. \end{cases}$$

In spherical coordinates, the semi-lines

$$\gamma_- = \Gamma(B, \theta_-, \varphi_-) = (A_-B], \text{ where } [AB] \subset (A_-B];$$

$$\gamma_+ = \Gamma(A, \theta_+, \varphi_+) = [AB_+), \text{ where } [AB] \subset [AB_+)$$

are fixed by the angles

$$\begin{aligned} \varphi_- = \varphi_+ = \varphi &= \arcsin \frac{z_\Delta}{\rho} \\ \theta_- = \theta_+ = \theta &= \begin{cases} \arccos \frac{x_\Delta}{\rho \cos \varphi}, & y_\Delta > 0 \\ 2\pi - \arccos \frac{x_\Delta}{\rho \cos \varphi}, & y_\Delta < 0 \\ 0, & y_\Delta = 0, x_\Delta \geq 0 \\ \pi, & y_\Delta = 0, x_\Delta < 0. \end{cases} \end{aligned}$$

*Proof.* We use the relations

$$\begin{cases} x_\Delta = \rho \cos \theta \cos \varphi \\ y_\Delta = \rho \sin \theta \cos \varphi \\ z_\Delta = \rho \sin \varphi, \end{cases} \quad (\rho, \theta, \varphi) \in \mathbb{R}_+^* \times [0, 2\pi) \times \left[-\frac{\pi}{2}, \frac{\pi}{2}\right].$$

Let  $c : I \rightarrow \mathbb{R}^3$  be a parametrized curve, with  $c(I)$  closed or unbounded at both edges ("closed at infinity"), traversed by the current  $\vec{J} = I\dot{c} / \|\dot{c}\|$ . Let  $\vec{H}_\gamma$  be the magnetic field associated to the electric circuit  $\gamma = \text{Im } c$ .

**Proposition 1.** *If  $\mathcal{T} : \mathbb{R}^3 \rightarrow \mathbb{R}^3$  is a translation and  $\mathcal{R} : \mathbb{R}^3 \rightarrow \mathbb{R}^3$  is a rotation, then*

$$a) \vec{H}_{\mathcal{R}\gamma}(\mathcal{R}M) = \mathcal{R}\vec{H}_\gamma(M);$$

$$b) \vec{H}_{\mathcal{T}\gamma}(\mathcal{T}M) = \vec{H}_\gamma(M);$$

$$c) \vec{H}_{\mathcal{J}\gamma}(\mathcal{J}M) = \mathcal{R}\vec{H}_\gamma(M),$$

for all  $M \in \mathbb{R}^3 \setminus \gamma$ , where  $\mathcal{J} = \mathcal{T} \circ \mathcal{R}$ .

*Proof.* We shall use the following notations

$$\begin{cases} \bar{v} = \dot{c}/\|\dot{c}\|, & d\tau_P = \|\dot{c}\|dt, \\ \overline{PM} = \overline{OM} - \bar{c}, & P = c(t) \in \gamma, M \in \mathbb{R}^3 \setminus \gamma. \end{cases}$$

a)  $\mathcal{R}\gamma$  is parametrized by  $\mathcal{R}c : I \rightarrow \mathbb{R}^3$  and we have

$$\begin{cases} R\bar{v} = R\dot{c}/\|R\dot{c}\| = R\dot{c}/\|\dot{c}\|, & d\tau_{Rp} = \|R\dot{c}\|dt = \|\dot{c}\|dt, \\ \overline{R_P R_M} = R\bar{w} - R\bar{c} = R(\bar{w} - \bar{c}), \end{cases}$$

where we denoted  $\bar{w} = \overline{OM}$ . Then the magnetic field of the rotated curve will be

$$\bar{H}_{\mathcal{R}\gamma}(\mathcal{R}M) = \int_I \frac{R\bar{v} \times R(\bar{w} - \bar{c})}{\|R(\bar{w} - \bar{c})\|^3} \|\dot{c}\|dt = \mathcal{R} \circ \int_I \frac{\bar{v} \times (\bar{w} - \bar{c})}{\|(\bar{w} - \bar{c})\|^3} dt = \mathcal{R}\bar{H}_\gamma(\overline{M}),$$

$$\forall M(x, y, z) \in \mathbb{R}^3 \setminus \gamma.$$

b) For the translation  $\mathcal{T}$ , denoting  $c : I \rightarrow \mathbb{R}^3$ , we have

$$\overline{\mathcal{T}(P)\mathcal{T}(M)} = \overline{PM} = \overline{OM} - \overline{c(t)},$$

where  $P = c(t)$ . Using this equality, we get

$$H_{\mathcal{T}\gamma}(\mathcal{T}M) = H_\gamma(M).$$

We remark that c) is a consequence of the relations a) and b).

More generally, we can state the following result:

**Proposition 2.** *Let  $\gamma$  be an elementary spatial configuration traversed by an unitary electric current  $\bar{J}$  and let  $\varphi$  be an isometry of the space  $\mathbb{R}^3$ ; let  $\bar{H}_\gamma$  and  $\bar{H}_{\tilde{\gamma}}$  be respectively the magnetic fields associated to the configurations  $\gamma$  and  $\tilde{\gamma} = \varphi\gamma$ , then the magnetic field associated to the elementary configuration  $\tilde{\gamma}$  is given by*

$$\bar{H}_{\tilde{\gamma}}(N) = \epsilon(\varphi)\varphi_*\bar{H}_\gamma(\varphi^{-1}N), \forall N \in \mathbb{R}^3 \setminus \tilde{\gamma}, (1)$$

where  $\varphi_*$  is the orthogonal linear mapping associated to the isometry  $\varphi$ , and

$$\epsilon(\varphi) = \det(\varphi_*).$$

*Proof.* Considering that on  $\gamma = Imc, c : I \rightarrow \mathbb{R}^3$  we have  $\bar{J} = \bar{c}', \alpha = \varphi \circ c$ , and by using the Biot-Savart-Laplace formula, we get

$$\begin{aligned} \bar{H}_{\tilde{\gamma}}(\varphi(M)) &= \int_{\varphi(\gamma)} \frac{\alpha'(t) \times \overline{\alpha(t)\varphi(M)}}{\|\overline{\alpha(t)\varphi(M)}\|^3} dt = \int_{\varphi(\gamma)} \frac{\varphi_*(\overline{c'(t)}) \times \overline{\varphi(c(t))\varphi(M)}}{\|\overline{\varphi(c(t))\varphi(M)}\|^3} dt = \\ &= \int_{\varphi(\gamma)} \frac{\varphi_*(\overline{c'(t)}) \times \varphi_*(\overline{c(t)M})}{\|\varphi_*(\overline{c(t)M})\|^3} dt = \epsilon(\varphi) \int_\gamma \frac{\overline{c'(t)} \times \overline{c(t)M}}{\|\overline{c(t)M}\|^3} dt = \\ &= \epsilon(\varphi)\bar{H}_\gamma(M), \forall M \in \mathbb{R}^3 \setminus \gamma. \end{aligned}$$

By denoting  $N = \varphi(M)$ , i.e.,  $M = \varphi^{-1}(N)$ , we obtain the relation (1). In the proof we used the known result, that for any orthogonal mapping  $A \in \mathcal{O}(\mathbb{R}^3)$  of the vector space  $\mathbb{R}^3$ , the following relations hold true

$$\begin{aligned} A(\bar{u} \times \bar{v}) &= \epsilon(A)A(\bar{u}) \times A(\bar{v}), \forall \bar{u}, \bar{v} \in \mathbb{R}^3, \\ \|A\bar{u}\| &= \|\bar{u}\|, \forall \bar{u} \in \mathbb{R}^3. \end{aligned}$$

Regarding  $U_{\tilde{\gamma}}$  and  $\bar{\Phi}_{\tilde{\gamma}}$  we can state the following results:

**Proposition 3.** *The scalar potential  $U_{\tilde{\gamma}}$  associated to the elementary configuration  $\tilde{\gamma}$  is given by*

$$U_{\tilde{\gamma}}(N) = U_{\gamma}(\varphi^{-1}N), \quad \forall N \in \mathbb{R}^3 \setminus \tilde{\gamma}.$$

**Proposition 4.** *The vector potential  $\bar{\Phi}_{\tilde{\gamma}}$  associated to the elementary configuration  $\tilde{\gamma}$  is given by*

$$\bar{\Phi}_{\tilde{\gamma}}(N) = \epsilon(\varphi)\varphi_*\bar{\Phi}_{\gamma}(\varphi^{-1}N), \quad \forall N \in \mathbb{R}^3 \setminus \tilde{\gamma}.$$

In the following, we shall consider the case in which  $\varphi$  is a congruence, hence the associated orthogonal mapping  $\varphi_*$  is a rotation and therefore  $\epsilon(\varphi) = 1$ .

For deriving the magnetic field and the associated potentials of an arbitrary elementary configuration, we shall apply the previous result to a pair of elementary plane semi-lines (located inside the plane  $xOz$ , Fig. 6), whose BSL associated integrals are provided by

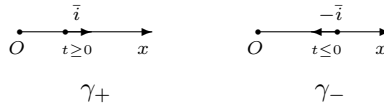

Fig. 6

**Lemma 3.** *Let be the elementary plane semi-lines from Fig.6, described by*

$$\begin{cases} \gamma_+ = \text{Im } c_1, & c_1(t) = (t, 0, 0), \quad t \geq 0 \text{ and } z \\ \gamma_- = \text{Im } c_2, & c_2(t) = (-t, 0, 0), \quad t \leq 0. \end{cases}$$

*Then the BSL integrals have on these semi-lines the form*

$$\bar{H}_{\gamma_+}(M) = \frac{x+r}{u^2 r}(0, -z, y), \quad \bar{H}_{\gamma_-}(M) = -\frac{x+r}{u^2 r}(0, -z, y),$$

where

$$u^2 = y^2 + z^2, r = (x^2 + y^2 + z^2)^{1/2}, M(x, y, z) \in \mathbb{R}^3 \setminus \gamma_+,$$

and the vector potential is, respectively

$$\Phi_{\gamma_+}(M) = -\ln |r - x| \vec{i}, \quad \Phi_{\gamma_-}(M) = \ln |r - x| \vec{i}.$$

*Proof.* a) For the semi-line  $\gamma_+$ , denoting  $c = c_1$ , we notice that  $\text{Im } c \subset Ox$  and the traversing sense given by the velocity  $\dot{c}$  coincides with the positive sense of the axis  $Ox$ . Let  $M(x, y, z) \in \mathbb{R}^3, \bar{w} = \overline{OM}$ . We have  $\bar{c}(t) = t\vec{i} \equiv (t, 0, 0), t \geq 0$ , and

$$\overline{PM} = \bar{w} - \bar{c} \equiv (x - t, y, z), \dot{\bar{c}}(t) = \vec{i} \equiv (1, 0, 0), \bar{v} \equiv \dot{\bar{c}}/\|\dot{\bar{c}}\|.$$

Then the BSL integral for the semi-line  $\gamma_+$  is

$$\begin{aligned}
\bar{H}_{\gamma_+}(M) &= \int_{\gamma_+} \frac{\bar{v} \times \overline{PM}}{\|\overline{PM}\|^3} d\tau_P = \int_0^\infty \frac{\bar{v} \times (\bar{w} - \bar{c})}{\|\bar{w} - \bar{c}\|^3} \|\dot{\bar{c}}(t)\| dt = \\
&= \int_0^\infty \begin{vmatrix} \bar{i} & \bar{j} & \bar{k} \\ 1 & 0 & 0 \\ x-t & y & z \end{vmatrix} \cdot \frac{dt}{(\sqrt{(x-t)^2 + y^2 + z^2})^3} = \\
&= (y\bar{k} - z\bar{j}) \cdot \int_0^\infty \frac{dt}{(\sqrt{(t-x)^2 + u^2})^3} = (y\bar{k} - z\bar{j}) \cdot \frac{t-x}{u^2 \sqrt{(t-x)^2 + u^2}} \Big|_{t=0}^{t=\infty} = \\
&= (y\bar{k} - z\bar{j}) \cdot \left[ \frac{1}{u^2} + \frac{x}{u^2 \sqrt{x^2 + y^2 + z^2}} \right] = \frac{x+r}{u^2 r} \cdot (y\bar{k} - z\bar{j}) = \frac{x+r}{u^2 r} \cdot (0, -z, y),
\end{aligned}$$

where  $\|\dot{\bar{c}}(t)\| = \|\bar{i}\| = 1$ ,  $\bar{c} = \overline{OP}$ , and we denoted

$$u^2 = y^2 + z^2, \bar{w} = \overline{OM}, r = \|\bar{w}\| = (x^2 + y^2 + z^2)^{1/2}, M(x, y, z) \in \mathbb{R}^3 \setminus \gamma_+.$$

b) For the semi-line  $\gamma_-$ , by denoting  $c = c_2$ , we notice that  $\text{Im } c \subset Ox$ , with opposite traversing sense, vs. the positive sense of the  $Ox$  axis,  $\bar{c}(t) = -t\bar{i}$ ,  $t \geq 0$ .

Let  $M(x, y, z) \in \mathbb{R}^3$ ,  $\bar{w} = \overline{OM}$ . We have

$$\overline{PM} = \bar{w} - \bar{c} \equiv (x+t, y, z), \dot{\bar{c}} = -\bar{i}, \bar{v} = \dot{\bar{c}}/\|\dot{\bar{c}}\| = -\bar{i} \equiv (-1, 0, 0)$$

and the BSL integral on the semi-line  $\gamma_-$  is

$$\begin{aligned}
\bar{H}_{\gamma_-}(M) &= \int_{\gamma_-} \frac{\bar{v} \times \overline{PM}}{\|\overline{PM}\|^3} d\tau_P = \int_{-\infty}^0 \begin{vmatrix} \bar{i} & \bar{j} & \bar{k} \\ -1 & 0 & 0 \\ x-t & y & z \end{vmatrix} \frac{dt}{\sqrt{(x-t)^2 + u^2}} = \\
&= -(y\bar{k} - z\bar{j}) \cdot \frac{t+x}{u^2 \sqrt{(t+x)^2 + u^2}} \Big|_{t=-\infty}^{t=0} = -(y\bar{k} - z\bar{j}) \cdot \left( \frac{x}{u^2 r} + \frac{1}{u^2} \right) \equiv \\
&\equiv -\frac{x+r}{u^2 r} (0, -z, y).
\end{aligned}$$

We remark that  $\bar{H}_{\gamma_-}(M) = -\bar{H}_{\gamma_+}(M)$  and we can easily check straightforward that the following functions have as curl the two BSL  $\bar{H}_{\gamma_+}$  and  $\bar{H}_{\gamma_-}$ , respectively,

$$\begin{cases} \bar{\Phi}_{\gamma_+}(M) = -\ln |r-x| \bar{i} \\ \bar{\Phi}_{\gamma_-}(M) = \ln |r-x| \bar{i}. \end{cases}$$

In the following we shall determine the isometries which provide from the semi-lines  $\gamma_+, \gamma_-$  from Lemma 3, the angular elementary configurations.

**Remarks.** Let  $\mathcal{R}_\theta$  the rotation of angle  $\theta$  around the  $Oz$  axis in trigonometric sense (from  $Ox$  to  $Oy$ ), and  $\mathcal{R}_\varphi$  the rotation around the  $Oy$  axis (from  $Ox$  to  $Oz$ ). Then we have

a) The matrices  $R_\theta$ , respectively  $R_\varphi$  associated to the two rotations are

$$R_\theta = \begin{pmatrix} c' & -s' & 0 \\ s' & c' & 0 \\ 0 & 0 & 0 \end{pmatrix}, R_\varphi = \begin{pmatrix} c & 0 & -s \\ 0 & 1 & 0 \\ s & 0 & c \end{pmatrix}$$



and we have

$$R_{\theta\varphi} \stackrel{=}{=} R_{\theta} R_{\varphi} = \begin{pmatrix} cc' & -s' & -sc' \\ cs' & c' & -ss' \\ s & 0 & c \end{pmatrix},$$

where we denoted

$$\begin{cases} c' = \cos \theta \\ s' = \sin \theta \end{cases} \quad \begin{cases} c = \cos \varphi \\ s = \sin \varphi. \end{cases}$$

b) We have the relations

$$R_{\theta\varphi}^{-1} = {}^t R_{\theta\varphi} = {}^t R_{\varphi} \cdot {}^t R_{\theta} = R_{\varphi}^{-1} \cdot R_{\theta}^{-1} = R_{-\varphi} \cdot R_{-\theta}$$

c) For a point  $M(x, y, z) \in \mathbb{R}^3$ , the associated position vector  $\bar{r} = \overline{OM}$  can be written  $\bar{r} \equiv (x, y, z) = (rcc', rcs', rs)$ , and the versors of the associated spherical moving frame

$$\left\{ \bar{e}_r = \left\| \frac{\partial \bar{r}}{\partial r} \right\|^{-1} \cdot \frac{\partial \bar{r}}{\partial r}, \bar{e}_{\theta} = \left\| \frac{\partial \bar{r}}{\partial \theta} \right\|^{-1} \cdot \frac{\partial \bar{r}}{\partial \theta}, \bar{e}_{\varphi} = \left\| \frac{\partial \bar{r}}{\partial \varphi} \right\|^{-1} \cdot \frac{\partial \bar{r}}{\partial \varphi} \right\},$$

form an orthonormal basis, whose matrix is

$$R_{\theta\varphi} = [\bar{e}_r, \bar{e}_{\theta}, \bar{e}_{\varphi}].$$

Hence, the spherical frame can be obtained by rotating the canonic frame  $\{\bar{i}, \bar{j}, \bar{k}\}$  with the angle  $\varphi$  around the  $Oy$  axis (with the sense from  $Ox$  towards  $Oz$ ), followed by a rotation of angle  $\theta$  around the  $Oz$  axis (with the sense from  $Ox$  towards  $Oy$ )-see Fig.7.

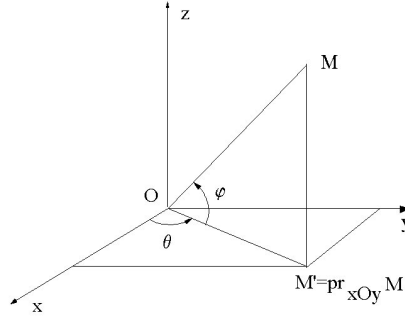

Fig. 7

d) Let  $\mathcal{R}_{\gamma}$  the rotation of angle  $\gamma$  around the  $Ox$  axis;  $\mathcal{R}_{\gamma}$  has the associated matrix

$$R_{\gamma} = \begin{pmatrix} 1 & 0 & 0 \\ 0 & \tilde{c} & -\tilde{s} \\ 0 & \tilde{s} & \tilde{c} \end{pmatrix}, \text{ where } \begin{cases} \tilde{c} = \cos \gamma \\ \tilde{s} = \sin \gamma \end{cases}, \gamma \in [0, 2\pi).$$

Then

$$\mathcal{R}_{\theta\varphi\gamma} \stackrel{=}{=} \mathcal{R}_{\theta} \mathcal{R}_{\varphi} \mathcal{R}_{\gamma} = \begin{pmatrix} cc' & -s'\tilde{c} - sc'\tilde{s} & s'\tilde{s} - sc'\tilde{c} \\ cs' & c'\tilde{c} - ss'\tilde{s} & -c'\tilde{s} - ss'\tilde{c} \\ s' & c\tilde{s} & c\tilde{c} \end{pmatrix}.$$

### 3 Applications to particular angular configurations

Using the results of the previous section, for the case  $\theta = 0$ , we get the following known results regarding plane elementary configurations  $\Gamma \subset xOz$ .

**Corollary 1.** *Let be a plane angular configuration  $\Gamma = \Gamma_p(V, \alpha, \beta) \subset xOz$ , of vertex  $V(a, b, c)$ ,  $b = 0$ , which is traversed by a unitary current, as in Fig.8,*

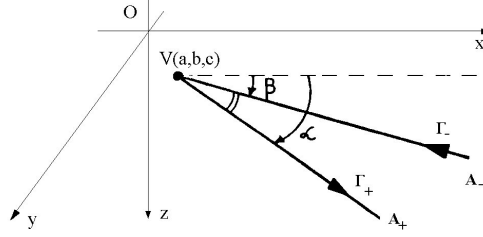

Fig. 8

The magnetic field and its vector and scalar potentials associated to the configuration  $\Gamma$  have respectively the form

$$\vec{H}_\Gamma(M) = \frac{1}{r(r-\tau)}(-vs, us - wc, vc) - \frac{1}{r(r-\bar{\tau})}(-v\bar{s}, u\bar{s} - w\bar{c}, v\bar{c}), \forall M \in \mathbb{R}^3 \setminus \Gamma,$$

$$\vec{\Phi}_\Gamma(M) = \vec{\Phi}_+ + \vec{\Phi}_-, \quad \begin{cases} \vec{\Phi}_+ = -\ln |r - \tau| (c, 0, s), \\ \vec{\Phi}_- = \ln |r - \bar{\tau}| (\bar{c}, 0, \bar{s}), \end{cases} \forall M \in \mathbb{R}^3 \setminus \Gamma,$$

$$U_\Gamma(M) = 2 \arctan \frac{-w \sin \frac{\sigma}{2} - u \cos \frac{\sigma}{2} + r \cos \frac{\Delta}{2}}{v \sin \frac{\Delta}{2}}, \forall M \in \mathbb{R}^3 \setminus xOz,$$

where we denoted

$$\begin{cases} c = \cos \alpha, s = \sin \alpha, \bar{c} = \cos \beta, \bar{s} = \sin \beta, \\ \Delta = \alpha - \beta, \sigma = \alpha + \beta, \\ u = x - a, v = y - b, w = z - c, b = 0, \\ r = (u^2 + v^2 + w^2)^{1/2}, \tau = uc + ws, \bar{\tau} = u\bar{c} + w\bar{s}. \end{cases}$$

Moreover,  $\Gamma$  decomposes as follows

$$\Gamma = \Gamma_p(V, \varphi_+, \varphi_-) = (A_-V] \cup [VA_+) = \Gamma_+(V, 0, \varphi_+) \cup \Gamma_-(V, 0, \varphi_-),$$

where  $\varphi_+ = (\widehat{Ox, VA_+}) = \alpha$ ,  $\varphi_- = (\widehat{Ox, VA_-}) = \beta$ .

*Proof.* For  $\alpha = \varphi_+$  and  $\gamma_+ = [Ox)$ , we remark that the given configuration can be obtained by a rotation  $[OA_+) = \mathcal{R}_\alpha \gamma_+$ . From Proposition 2 and Lemma 3, we get

$$\begin{aligned} \vec{H}_{[OA_+)} &= \vec{H}_{\mathcal{R}_\alpha \gamma_+}(M) = \mathcal{R}_\alpha \vec{H}_{\gamma_+}(\mathcal{R}_{-\alpha} M) \\ &= \begin{pmatrix} c & 0 & -s \\ 0 & 1 & 0 \\ s & 0 & c \end{pmatrix} \cdot \begin{pmatrix} 0 \\ us - wc \\ v \end{pmatrix} \cdot \frac{1}{r - \tau} \cdot \frac{1}{r} = \\ &= \frac{1}{r(r - (uc + vs))} {}^t(-vs, us - wc, vc), \quad \forall M = (x, y, z) \in \mathbb{R}^3 \setminus [OA_+), \end{aligned}$$

where we denoted  $c = \cos \alpha$ ,  $s = \sin \alpha$ ,  $\tau = uc + ws$ .

Similarly, for  $\beta = \varphi_-$  and  $\gamma_- = (xO]$ , we have  $(A_-O] = \mathcal{R}_{\beta}\gamma_-$ , and hence

$$\begin{aligned}\bar{H}_{(A_-O]} &= \bar{H}_{\mathcal{R}_{\beta}\gamma_-}(M) = \mathcal{R}_{\beta}\bar{H}_{\gamma_-}(\mathcal{R}_{-\beta}M) \\ &= \frac{-1}{r(r - (u\bar{c} + w\bar{s}))} \cdot (-v\bar{s}, u\bar{s} - w\bar{c}, v\bar{c}).\end{aligned}$$

Adding the two fields, and composing with  $\mathcal{T}^{-1}$  we get  $\bar{H}_{\gamma}$ . Similarly we obtain also the vector potential  $\Phi_{\Gamma}$  associated to the circuit  $\Gamma$ ; by integrating the field  $\bar{H}_{\Gamma}$ , we get also the scalar potential  $U_{\Gamma}$ . We notice that for  $\alpha = \beta$  we have  $\bar{H}_{\gamma_-} = -\bar{H}_{\gamma_+}$ .

**Corollary 2.** *In particular, for  $\Gamma = \Gamma_p(V, \alpha, -\alpha)$ , (see Fig.9)*

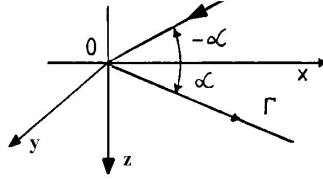

Fig. 9

we have the magnetic field and its associated vector and scalar potentials, respectively

$$\begin{aligned}\bar{H}_{\Gamma}(M) &\equiv \left[ \frac{-vs}{r} \left( \frac{1}{r-\tau_1} + \frac{1}{r-\tau_2} \right), \frac{1}{r} \left( \frac{us-wc}{r-\tau_1} + \frac{us+wc}{r-\tau_2} \right), \frac{vc}{r} \left( \frac{1}{r-\tau_1} - \frac{1}{r-\tau_2} \right) \right], \\ \bar{\Phi}_{\Gamma}(M) &\equiv \left( \ln \left| \frac{r-uc+ws}{r-uc-ws} \right|^c, 0, -\ln |(r-uc+ws)(r-uc-ws)|^s \right), \quad \forall M \in \mathbb{R}^3 \setminus \Gamma, \\ U_{\Gamma}(M) &= 2 \arctan \frac{-u+r \cos \alpha}{v \sin \alpha}, \quad \forall M \in \mathbb{R}^3 \setminus xOz,\end{aligned}$$

where we denoted

$$\begin{cases} c = \cos \alpha, s = \sin \alpha, \quad \tau_1 = cu + sw, \tau_2 = cu - sw, \\ r = (u^2 + v^2 + w^2)^{1/2}, y \neq b \equiv 0.\end{cases}$$

**Corollary 3.** *For the configuration given by a straight line  $\Gamma = \Gamma_p(V, \alpha, \alpha + \pi)$ , see Fig.10, we find*

$$\begin{aligned}\bar{H}_{\Gamma}(M) &= \left[ \frac{-vs}{r} \left( \frac{1}{r-\tau} + \frac{1}{r+\tau} \right), \frac{us-wc}{r} \left( \frac{1}{r-\tau} + \frac{1}{r+\tau} \right), \frac{vc}{r} \left( \frac{1}{r-\tau} + \frac{1}{r+\tau} \right) \right] = \\ &= \frac{2}{\rho} (vs, us - wc, vc), \quad \forall M \in \mathbb{R}^3 \setminus \Gamma, \\ \bar{\Phi}_{\Gamma}(M) &= \left( -\ln |(r-uc-ws)(r+uc+ws)|^c, 0, -\ln \left| \frac{(r-uc-ws)}{(r+uc+ws)} \right|^s \right) = \\ &= -\ln \rho \cdot (c, 0, s), \quad \forall M \in \mathbb{R}^3 \setminus \Gamma, \\ U_{\Gamma}(M) &= 2 \arctan \frac{wc-us}{v}, \quad \forall M \in \mathbb{R}^3 \setminus xOz,\end{aligned}$$

where

$$\begin{cases} \rho = r^2 - (uc + ws)^2 = (wc - us)^2 + v^2, \\ \tau = uc + ws, c = \cos \alpha, s = \sin \alpha.\end{cases}$$

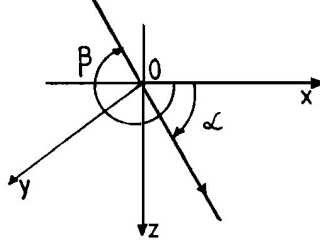

Fig. 10

Using the results obtained above, we can derive the magnetic field of an elementary spatial configuration. Let  $\Gamma = \gamma_+ \cup \gamma_-$ , where  $\gamma_+, \gamma_-$  are the semi-lines

$$\gamma_+ = \gamma(0, \theta_+, \varphi_+), \gamma_- = \gamma(0, \theta_-, \varphi_-),$$

as in the following figure:

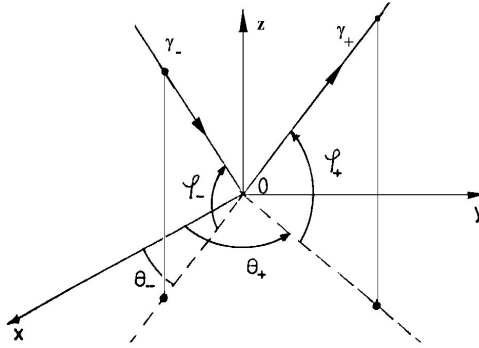

Fig. 11

**Theorem 1.** *The magnetic field of the configuration  $G$  and its vector potential are respectively  $\bar{H}_\Gamma = \bar{H}_{\gamma_+} + \bar{H}_{\gamma_-}$ , with*

$$\bar{H}_{\gamma_+} = \frac{1}{r(r-\tau)}(-ys + zcs', xs - zcc', -xcs' + ycc'),$$

$$\bar{H}_{\gamma_-} = -\frac{1}{r(r-\bar{\tau})}(-y\bar{s} + z\bar{c}\bar{s}', x\bar{s} - z\bar{c}\bar{c}', -x\bar{c}\bar{s}' + y\bar{c}\bar{c}')$$

and

$$\bar{\Phi}_\Gamma = \left( \ln \frac{|r - \bar{\tau}| \bar{c}\bar{c}'}{|r - \tau| cc'}, \ln \frac{|r - \bar{\tau}| \bar{c}\bar{s}'}{|r - \tau| cs'}, \ln \frac{|r - \bar{\tau}| \bar{s}}{|r - \tau| s} \right),$$

where we denoted

$$\tau = (x'c' + ys')c + zs, \bar{\tau} = (x'\bar{c}' + y\bar{s}')\bar{c} + z\bar{s}, r = (x^2 + y^2 + z^2)^{1/2},$$

and

$$\begin{cases} c = \cos \varphi_+, c' = \cos \theta_+ \\ s = \sin \varphi_+, s' = \sin \theta_+ \end{cases}, \begin{cases} \bar{c} = \cos \varphi_-, \bar{c}' = \cos \theta_- \\ \bar{s} = \sin \varphi_-, \bar{s}' = \sin \theta_- \end{cases}.$$

*Proof.* We use the relation  $\bar{H}_\Gamma = \bar{H}_{\gamma_+} + \bar{H}_{\gamma_-}$ , where

$$\bar{H}_{\gamma_+} = \mathcal{R}_{\theta_+\varphi_+} H_{\gamma_+^0}^t \circ \mathcal{R}_{\theta_+\varphi_+}^{-1}, \bar{H}_{\gamma_-} = \mathcal{R}_{\theta_-\varphi_-} H_{\gamma_-^0}^t \circ \mathcal{R}_{\theta_-\varphi_-}^{-1},$$

with  $\gamma_+^0$  and  $\gamma_-^0$  are respectively the elementary semi-lines traversed by current, from Lemma 1. The same result can be obtained by using the BSL integrals  $\bar{H}_{(OA_+)}$  and  $\bar{H}_{(A_-O]}$  from the proof of Corollary 1, obtaining, e.g.,

$$\bar{H}_{\gamma_+} = \mathcal{R}_{\theta_+} H_{(OA_+)}^t \circ \mathcal{R}_{\theta_+}^{-1},$$

Moreover, we notice that we have the relation

$$r = ((xc' + ys')^2 + (-xs' + yc')^2 + z^2)^{1/2} = (x^2 + y^2 + z^2)^{1/2}.$$

**Corollary 4.** *For the angular configuration*

$$\Gamma = \gamma_+ \cup \gamma_-,$$

of arbitrary vertex  $V(a, b, c)$  and semi-lines

$$\gamma_+ = \gamma(V, \theta_+, \varphi_+), \gamma_- = \gamma(V, \theta_-, \varphi_-),$$

the associated magnetic field has the expression  $\bar{H}_\gamma = \bar{H}_{\gamma_+} + \bar{H}_{\gamma_-}$ , with

$$\begin{cases} \bar{H}_{\gamma_+} = \frac{1}{r(r-\tau)}(-vs + wcs', us - wcc', -ucs' + vcc') \\ \bar{H}_{\gamma_-} = -\frac{1}{r(r-\bar{\tau})}(-v\bar{s} + w\bar{c}\bar{s}', u\bar{s} - w\bar{c}\bar{c}', -u\bar{c}\bar{s}' + v\bar{c}\bar{c}') \end{cases}$$

and its potential vector is

$$\bar{\Phi}_\Gamma = \left( \ln \frac{|r - \bar{\tau}| |\bar{c}\bar{c}'|}{|r - \tau| |cc'|}, \ln \frac{|r - \bar{\tau}| |\bar{c}\bar{s}'|}{|r - \tau| |cs'|}, \ln \frac{|r - \bar{\tau}| |\bar{s}|}{|r - \tau| |s|} \right),$$

where we denoted

$$(u, v, w) = (x - a, y - b, z - c), r = (u^2 + v^2 + w^2)^{1/2}$$

$$\tau = (uc' + vs')c + ws, \bar{\tau} = (u\bar{c}' + v\bar{s}')\bar{c} + w\bar{s},$$

and  $c, s, c', s', \bar{c}, \bar{s}, \bar{c}', \bar{s}'$  have the same meanings as in Theorem 1.

We shall prove in the following, that applying Proposition 1 we can provide also the scalar potential of the elementary configuration  $\Gamma$  from Theorem 1.

**Proposition 5.** *The scalar potential of the elementary configuration (see Fig.12)*

$$\Gamma = \gamma(O, \theta_+ = \theta, \varphi_+ = \varphi) \cup \gamma(O, \theta_- = \bar{\theta}, \varphi_- = \bar{\varphi})$$

has the form

$$U_\Gamma = 2 \arctan \frac{-x\bar{c}\bar{c} + y\bar{s}\bar{c} + z\bar{s} + r \cos \hat{\theta} \cos \hat{\varphi}}{x(\bar{c}\bar{s} \sin \hat{\theta} \cos \hat{\varphi} + \bar{s} \sin \hat{\varphi}) + y(\bar{c} \sin \hat{\varphi} - \bar{s}\bar{s} \sin \hat{\theta} \cos \hat{\varphi}) - z\bar{c} \sin \hat{\theta} \cos \hat{\varphi}},$$

where we denoted

$$\begin{cases} \tilde{s} = \sin \tilde{\varphi} \\ \tilde{c} = \cos \tilde{\varphi} \end{cases} \quad \begin{cases} \bar{s} = \sin \bar{\theta}, \\ \bar{c} = \cos \bar{\theta} \end{cases} \quad \begin{cases} s = \sin \psi, \\ c = \cos \psi, \end{cases}$$

$$\hat{\theta} = \frac{\theta - \bar{\theta}}{2}, \hat{\varphi} = \frac{\varphi - \bar{\varphi}}{2}, \quad \tilde{\theta} = \frac{\theta + \bar{\theta}}{2}, \quad \tilde{\varphi} = \frac{\varphi + \bar{\varphi}}{2}.$$

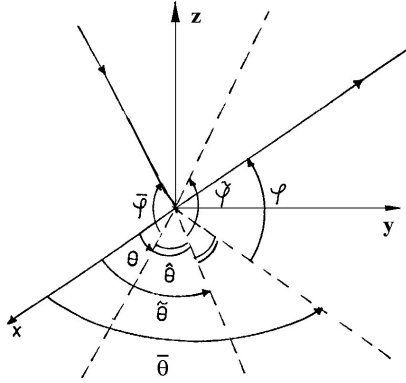

Fig. 12

*Proof.* We notice that by rotating the configuration  $\Gamma$ ,

$$\mathcal{R}_{-\tilde{\varphi}} \mathcal{R}_{-\tilde{\theta}} \Gamma = \tilde{\Gamma},$$

we produce the configuration

$$\tilde{\Gamma} = \Gamma(0, \hat{\theta}, \hat{\varphi}) \cup \Gamma(0, -\hat{\theta}, -\hat{\varphi})$$

which is symmetric relative to the  $Ox$  axis. As well, we fulfill the conditions for having:

- the (equal) angles  $\eta$  of the semi-lines of the configuration  $\tilde{\Gamma}$  with the  $Ox$  axis,
- the angle  $\psi$  of the necessary rotation for including the configuration  $\tilde{\Gamma}$  in the  $xOz$  plane (see Fig. 13)

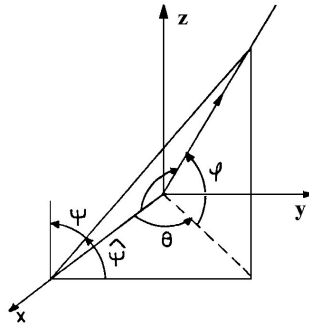

Fig. 13

$$(U_1) \quad \begin{cases} \cos \eta = \cos \hat{\theta} \cos \hat{\varphi}, \eta \in [0, \pi] \\ \sin \hat{\psi} = \frac{\sin \hat{\varphi}}{\sin \eta}, \cos \hat{\psi} = tg \hat{\theta} / tg \eta, \end{cases}$$

$$(U_2) \quad \begin{cases} \cos \psi = \frac{\sin \hat{\varphi}}{\sin \eta}, \\ \sin \psi = \frac{tg \hat{\theta}}{tg \eta} = \sin \hat{\theta} \frac{\cos \hat{\varphi}}{\sin \eta}, \end{cases}$$

where  $\hat{\psi} = \frac{\pi}{2} - \psi$ , and

$$\begin{cases} \sin \eta = \frac{\sin \hat{\varphi}}{\cos \psi} \\ \cos \eta = \cos \hat{\theta} \cos \hat{\varphi}. \end{cases}$$

Then applying the rotation  $\mathcal{R}_\psi \tilde{\Gamma} = \Gamma_0$ , we get the configuration (which is symmetric w.r.t. the  $Ox$  axis)

$$\Gamma_0 = \Gamma_p(0, \alpha = \eta, \beta = -\eta) \subset xOz$$

which is a configuration of the type studied in corollary 2; also, we have

$$\mathcal{R}_\psi \Gamma = \mathcal{R}_\psi \cdot \mathcal{R}_{-\hat{\varphi}} \cdot \mathcal{R}_{-\hat{\theta}} \cdot \Gamma;$$

whence

$$\Gamma = \mathcal{R}_{\hat{\theta}} \cdot \mathcal{R}_{\hat{\varphi}} \cdot \mathcal{R}_{-\psi} \cdot \Gamma_0.$$

Therefore, we have  $U_\Gamma = U_{\Gamma_0} \cdot \mathcal{J}^{-1}$ , where  $\mathcal{J}$  is an orthogonal mapping, namely a rotation of matrix

$$M = R_{\hat{\theta}} \cdot R_{\hat{\varphi}} \cdot R_{-\psi}.$$

The matrix of the inverse transform  $\mathcal{J}^{-1}$  will be

$$\begin{aligned} M^{-1} &= R_\psi \cdot {}^t R_{\hat{\varphi}} \cdot {}^t R_{\hat{\theta}} = \\ &= \begin{pmatrix} 1 & 0 & 0 \\ 0 & \cos \psi & -\sin \psi \\ 0 & \sin \psi & \cos \psi \end{pmatrix} \cdot \begin{pmatrix} \cos \tilde{\varphi} & 0 & \sin \tilde{\varphi} \\ 0 & 1 & 0 \\ -\sin \tilde{\varphi} & 0 & \cos \tilde{\varphi} \end{pmatrix} \cdot \begin{pmatrix} \cos \tilde{\theta} & \sin \tilde{\theta} & 0 \\ -\sin \tilde{\theta} & \cos \tilde{\theta} & 0 \\ 0 & 0 & 1 \end{pmatrix} = \\ &= \begin{pmatrix} 1 & 0 & 0 \\ 0 & c & -s \\ 0 & s & c \end{pmatrix} \cdot \begin{pmatrix} \tilde{c} & 0 & \tilde{s} \\ 0 & 1 & 0 \\ -\tilde{s} & 0 & \tilde{c} \end{pmatrix} \cdot \begin{pmatrix} \bar{c} & \bar{s} & 0 \\ -\bar{s} & \bar{c} & 0 \\ 0 & 0 & 1 \end{pmatrix} = \\ &= \begin{pmatrix} \tilde{c} & 0 & \tilde{s} \\ s\tilde{s} & c & -s\tilde{c} \\ -c\tilde{s} & s & c\tilde{c} \end{pmatrix} \cdot \begin{pmatrix} \bar{c} & \bar{s} & 0 \\ -\bar{s} & \bar{c} & 0 \\ 0 & 0 & 1 \end{pmatrix} = \\ &= \begin{pmatrix} \bar{c}\tilde{c} & \bar{s}\tilde{c} & \tilde{s} \\ s\bar{c}\tilde{s} - c\bar{s} & s\bar{s}\tilde{s} + c\bar{c} & -s\bar{c} \\ -c\bar{c}\tilde{s} - s\bar{s} & c\bar{s}\tilde{s} + s\bar{c} & c\bar{c} \end{pmatrix}, \end{aligned}$$

where we denoted  $\tilde{s} = \sin \tilde{\varphi}$ ,  $\tilde{c} = \cos \tilde{\varphi}$ ;  $\bar{s} = \sin \tilde{\theta}$ ,  $\bar{c} = \cos \tilde{\theta}$ ;  $s = \sin \psi$ ,  $c = \cos \psi$ .  
Since

$$U_{\Gamma_0} = 2 \arctan \frac{-x + r \cos \eta}{y \sin \eta}, \quad r = (x^2 + y^2 + z^2)^{1/2},$$

we obtain finally the scalar potential associated to the configuration  $\Gamma$ ,

$$\begin{aligned} U_\Gamma &= 2 \arctan\{-x\bar{c}\bar{c} + y\bar{s}\bar{c} + z\bar{s} + r \cos \hat{\theta} \cos \hat{\varphi}\} \cdot \\ &\quad \cdot [(x(s\bar{c}\bar{s} - c\bar{s}) + y(c\bar{c} + s\bar{s}\bar{s}) - zs\bar{c})s]^{-1}\} = \\ &= 2 \arctan[(-x\bar{c}\bar{c} + y\bar{s}\bar{c} + z\bar{s} + r \cos \hat{\theta} \cos \hat{\varphi}) \cdot \Theta^{-1}], \end{aligned}$$

where

$$\Theta = \left[ x \left( \bar{c}\bar{s} \frac{\sin \hat{\theta} \cos \hat{\varphi}}{s} - \bar{s} \frac{\sin \hat{\varphi}}{s} \right) + y \left( \bar{c} \frac{\sin \hat{\varphi}}{s} + \bar{s}\bar{s} \frac{\sin \hat{\theta} \cos \hat{\varphi}}{s} \right) - z\bar{c} \frac{\sin \hat{\theta} \cos \hat{\varphi}}{s} \right] s,$$

which proves the theorem.  $\square$

We can also state the following result, regarding the scalar potential of an angular spatial configuration of arbitrary vertex.

**Corollary 6.** *The scalar potential of the elementary configuration of the vertex  $V = (a, b, c) \in \mathbb{R}^3$ ,*

$$\Gamma = \gamma(V, \theta_+ = \theta, \varphi_+ = \varphi) \cup \gamma(V, \theta_- = \bar{\theta}, \varphi_- = \bar{\varphi})$$

has the form

$$U_\Gamma = 2 \arctan \frac{-u\bar{c}\bar{c} + v\bar{s}\bar{c} + w\bar{s} + r \cos \hat{\theta} \cos \hat{\varphi}}{u(\bar{c}\bar{s} \sin \hat{\theta} \cos \hat{\varphi} + \bar{s} \sin \hat{\varphi}) + v(\bar{c} \sin \hat{\varphi} - \bar{s}\bar{s} \sin \hat{\theta} \cos \hat{\varphi}) - w\bar{c} \sin \hat{\theta} \cos \hat{\varphi}},$$

where we used the notations  $u = x - a, v = y - b, w = z - c$ .

## 4 Applications to skew polygonal nets and to polyhedral circuits

Based on the Corollaries 4 and 5, we can determine the magnetic field of a skew polygonal net, and of a polyhedral circuit, which satisfy the axioms (A1), (A2).

A particular case of such a spatial configuration is presented in

**Proposition 6.** *a) For the configuration (see Fig.14a)*

$$\Gamma = \gamma_+(O, \theta_+ = 0, \varphi_+ = 0) \cup \gamma_-(O, \theta_- = \bar{\theta}, \varphi_- = \bar{\varphi})$$

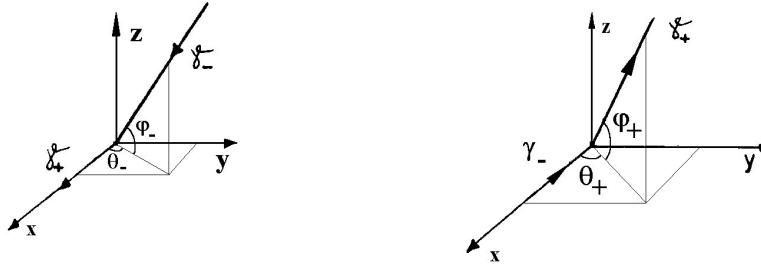

Fig. 14



we have,

$$\begin{aligned}\bar{H}_{\Gamma_a}(w) &= \frac{1}{r(r-x)}(0, -z, y) + \frac{-1}{r(r-\bar{\tau})}(-y\bar{s} + z\bar{c}s', x\bar{s} - z\bar{c}\bar{c}', -x\bar{c}s' + y\bar{c}\bar{c}'), \\ \bar{\Phi}_{\Gamma_a}(w) &= \left( \ln \frac{|r - \bar{\tau}|^{\bar{c}\bar{c}'}}{|r - x|}, \ln |r - \bar{\tau}|^{\bar{c}\bar{s}'}, \ln |r - \bar{\tau}|^{\bar{s}} \right), \forall w \in \mathbb{R}^3 \setminus \Gamma,\end{aligned}$$

where we denoted

$$\begin{cases} c = \cos \varphi_+, s = \sin \varphi_+, \bar{c} = \cos \varphi_-, \bar{s} = \sin \varphi_- \\ c' = \cos \theta_+, s' = \sin \theta_+, \bar{c}' = \cos \bar{\theta}_-, \bar{s}' = \sin \bar{\theta}_-, \end{cases}$$

and  $\bar{\tau} = (x\bar{c}' + y\bar{s}')\bar{c} + z\bar{s}$ .

b) For the configuration (see Fig.14b)

$$\Gamma = \gamma_+(0, \theta_+ = \theta, \varphi_+ = \varphi) \cup \gamma_-(0, \theta_- = 0, \varphi_- = 0)$$

we have, for all  $w \in \mathbb{R}^3 \setminus \Gamma$ ,

$$\begin{aligned}\bar{H}_{\Gamma_b}(w) &= \frac{1}{r(r-\tau)}(-ys + zcs', xs - zcc', -xcs' + ycc') - \frac{1}{r(r-x)}(0, -z, y) \\ \bar{\Phi}_{\Gamma_b}(w) &= \left( \ln(|r - x| |r - \tau|^{-cc'}), -\ln |r - \tau|^{cs'}, -\ln |r - \tau|^s \right).\end{aligned}$$

**Proposition 7.** a) For the configuration in Fig.15

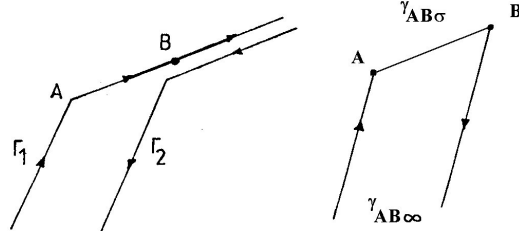

Fig. 15

given by  $\Gamma = \Gamma_1 \cup \Gamma_2$ , with

$$\begin{cases} \Gamma_1 = \gamma_+(A, \theta, \varphi) \cup \gamma_-(A, 0, 0), \\ \Gamma_2 = \gamma_+(B, 0, 0) \cup \gamma_-(B, \theta, \varphi), \end{cases}$$

where  $A(a, b, c), B(\bar{a}, \bar{b}, \bar{c}) \in \mathbb{R}^3$ , we get the magnetic field and the vector potential

$$\begin{aligned}\bar{H}_{\Gamma}(M) &= \bar{H}_{AB\sigma} + \bar{H}_{AB\infty}, \\ \bar{H}_{AB\sigma} &= -\frac{1}{\bar{r}(\bar{r}-\bar{\tau})}(-\bar{v}s + \bar{w}cs', \bar{u}s - \bar{w}c\bar{c}', -\bar{u}cs' + \bar{v}c\bar{c}') + \\ &\quad + \frac{1}{r(r-\tau)}(-vs + wcs', us - wcc', -ucs' + vcc'), \\ \bar{H}_{AB\infty} &= \frac{1}{r(r-u)}(0, -w, v) + \frac{1}{\bar{r}(\bar{r}-\bar{u})}(0, -w, v),\end{aligned}$$

$$\begin{aligned}\bar{\Phi}_\Gamma(M) &= \bar{\Phi}_{AB\sigma} + \bar{\Phi}_{AB\infty}, \\ \bar{\Phi}_{AB\sigma} &= \left( \ln \frac{|\bar{r}-\bar{\tau}|^{cc'}}{|r-\tau|^{cc'}}, \ln \frac{|\bar{r}-\bar{\tau}|^{cs'}}{|r-\tau|^{cs'}}, \ln \frac{|\bar{r}-\bar{\tau}|^s}{|r-\tau|^s} \right), \\ \bar{\Phi}_{AB\infty} &= \left( \ln \left| \frac{r-u}{\bar{r}-\bar{u}} \right|, 0, 0 \right),\end{aligned}$$

and the scalar potential has the form

$$\begin{aligned}U_\Gamma(M) &= 2 \left( \arctan \frac{-(u\bar{c} - v\bar{s})\tilde{c} + w\tilde{s} + r\bar{c}\tilde{c}}{u(\bar{s}\bar{c}\tilde{s}\tilde{c} + \bar{s}\tilde{s}) + v(\bar{c}\tilde{s} - \bar{s}^2\tilde{s}\tilde{c}) - w\bar{s}\bar{c}^2} - \right. \\ &\quad \left. - \arctan \frac{-(\bar{u}\bar{c} - \bar{v}\bar{s})\tilde{c} + \bar{w}\tilde{s} + \bar{r}\bar{c}\tilde{c}}{\bar{u}(\bar{s}\bar{c}\tilde{s}\tilde{c} + \bar{s}\tilde{s}) + \bar{v}(\bar{c}\tilde{s} - \bar{s}^2\tilde{s}\tilde{c}) - \bar{w}\bar{s}\bar{c}^2} \right) = U_{AB},\end{aligned}$$

where we denoted

$$\begin{cases} r = \|\nu\|, \nu = (u, v, w) \equiv (x - a, y - b, z - c) \\ \bar{r} = \|\bar{\nu}\|, \bar{\nu} = (\bar{u}, \bar{v}, \bar{w}) \equiv (x - \bar{a}, y - \bar{b}, z - \bar{c}) \end{cases}, \begin{cases} \tau = uc + ws \\ \bar{\tau} = \bar{u}\bar{c} + \bar{w}\bar{s} \end{cases}.$$

**Theorem 2.a)** For a skew polygon  $\Pi = A_1 \dots A_n$ , we have

$$\bar{H}_\Pi = \sum_{i=1}^n \bar{H}_{A_i A_{i+1} \sigma}, \bar{\Psi}_\pi = \sum_{i=1}^n \bar{\Psi}_{A_i A_{i+1} \sigma}, U_\pi = \sum_{i=1}^n U_{A_i A_{i+1}},$$

where we used the notation  $A_{n+1} = A_1$ , and the terms in the right sums are determined based on Proposition 7.

b) For a closed polyhedral circuit  $P$  of edges  $l_i$  which are oriented by the currents  $\bar{J}_i$  of intensities  $I_i$ ,  $i = \overline{1, m}$ , we have

$$\bar{H}_p = \sum_{i=1}^m I_i \cdot \bar{H}_{l_i \sigma}, \bar{\Phi}_p = \sum_{i=1}^m I_i \cdot \bar{\Phi}_{l_i \sigma}, U_p = \sum_{i=1}^m I_i \cdot U_{l_i},$$

where the terms in the right sums are determined based on Proposition 7.

**Remark.** At each knot of the configurations in the theorem, we have the II-nd Kirchoff law (the algebraic sum of the intensities vanishes; in the opposite case, the net does not admit a scalar potential  $U$ ).

**Proposition 8.** For the circuit from Fig.16 given by the union of elementary configurations

$$\begin{cases} \Gamma_1 = \gamma_+(A = O, \theta = \pi/2, \varphi = 0) \cup \gamma_-(A = O, 0, 0) \\ \Gamma_2 = \gamma_+(B, \theta, \varphi) \cup \gamma_-(B, \pi/2, 0), \end{cases}$$

where  $A = (0, 0, 0), B = (0, b, 0) \in \mathbb{R}^3$ , the magnetic field and the potentials have the form

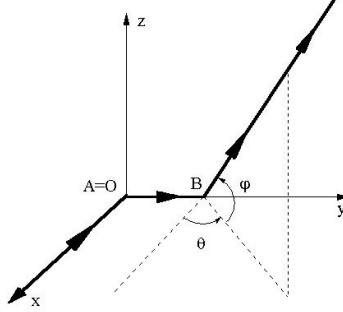

Fig. 16

$$\begin{aligned}
\bar{H}_\Gamma(M) &= \frac{1}{r(r-y)}(z, 0, -x) - \frac{1}{r(r-x)}(0, -z, y) + \\
&\quad + \frac{1}{\bar{r}(\bar{r}-\bar{\tau})}(-vs + zcs', xs - zcc', -xcs' + vcc') - \frac{1}{\bar{r}(\bar{r}-v)}(z, 0, -x), \\
\bar{\Phi}_\Gamma(M) &= \ln |r-x|, -\ln |r-y|, -\ln |r-y| + \\
&\quad + (-\ln |\bar{r}-\bar{\tau}|^{cc'}, \ln \frac{|\bar{r}-v|}{|\bar{r}-\bar{\tau}|^{cs'}}, -\ln |\bar{r}-\bar{\tau}|^{cs}), \\
U_\Gamma(M) &= 2 \left[ -\arctan \frac{(x-y)+r}{z} + \arctan \frac{-\bar{c}(x\bar{c}-y\bar{s})+z\bar{s}+r\bar{s}\bar{c}}{x(-\bar{c}^2\bar{s}^2+\bar{s}\bar{s})+y(\bar{c}\bar{s}+\bar{s}\bar{c}\bar{s}\bar{c})+z\bar{c}\bar{c}^2} \right],
\end{aligned}$$

where

$$\begin{cases} \bar{\tau} = (xc' + vs')c + zs, v = y - b, \\ r = (x^2 + y^2 + z^2)^{1/2}, \bar{r} = (x^2 + v^2 + z^2)^{1/2}, \\ c = \cos \varphi, c' = \cos \theta; \bar{c} = \cos \bar{\varphi}, \bar{c}' = \cos \bar{\theta}. \end{cases}$$

## 5 Magnetic lines and surfaces

Let  $\bar{H} = H_x \bar{i} + H_y \bar{j} + H_z \bar{k}$  a magnetic field on a domain  $D$  in  $\mathbb{R}^3$ . The magnetic lines (the field lines of  $\bar{H}$ ) are oriented curves which satisfy the (kinematic) system of differential equations

$$\frac{dx}{dt} = H_x, \frac{dy}{dt} = H_y, \frac{dz}{dt} = H_z,$$

and the magnetic surfaces (the field surfaces of  $\bar{H}$ ) are constant level sets attached to the solutions  $h$  of the PDE of first order

$$H_x \frac{\partial h}{\partial x} + H_y \frac{\partial h}{\partial y} + H_z \frac{\partial h}{\partial z} = 0.$$

A Cauchy problem for the differential system (1) consists of finding a solution

$$\alpha : I \rightarrow D, \alpha(t) = (x(t), y(t), z(t)), t \in I = (-\epsilon, \epsilon),$$

which emerges from the point  $x(0) = x_0, y(0) = y_0, z(0) = z_0$  at the moment  $t = 0$ .

The field surfaces are generated by field lines. A Cauchy problem for the PDE (2) consists of finding a field surface

$$\Sigma_c : h(x, y, z) = c,$$

which contains a curve  $\beta : J \rightarrow D$ , which is normal to the field lines. Since  $\bar{H}$  is of class  $C^\infty$ , the previous Cauchy problems have unique solutions.

The zeroes of the field  $\bar{H}$  are constant field lines, the equilibrium points of the kinematic system (2).

Let  $M(x, y, z) \in D$ . A maximal magnetic line

$$\alpha_M : I(M) \rightarrow D, \quad \alpha_M(0) = M$$

is defined on an open interval  $I(M) = (\omega_-(M), \omega_+(M))$  which contains the origin  $0 \in \mathbb{R}$ . The local flow

$$T_t : \mathcal{D}(\bar{H}) \rightarrow D, T_t(M) = \alpha_M(t),$$

where

$$\mathcal{D}(\bar{H}) = \{(t, x, y, z) \in \mathbb{R} \times D \mid \omega_-(M) < t < \omega_+(M)\},$$

is a mapping of class  $C^\infty$ , defined on the open set  $\mathcal{D}(\bar{H})$ . This flow preserves the volume, since  $\bar{H}$  is a solenoidal vector field.

In the following we are interested in those configurations which have open magnetic lines. As examples, we can enumerate the following

1) Configurations which consist of at least two electric coplanar circuits, which are piecewise rectilinear, and which have open magnetic lines.

We consider the configuration in Fig. 17, which has the magnetic field

$$\begin{aligned} H_x &= \frac{-y}{r_1(r_1 - z - b)} + \frac{y}{r_2(r_2 + z - b)} \\ H_y &= \frac{x + a}{r_1(r_1 - z - b)} - \frac{z + b}{r_1(r_1 + x + a)} - \frac{x - a}{r_2(r_2 + z - b)} + \frac{z - b}{r_2(r_2 - x + a)} \\ H_z &= \frac{y}{r_1(r_1 + x + a)} - \frac{y}{r_2(r_2 - x + a)}, \end{aligned}$$

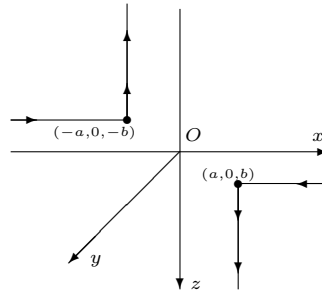

Fig. 17

where  $r_1 = \sqrt{(x+a)^2 + y^2 + (z+b)^2}$ ,  $r_2 = \sqrt{(x-a)^2 + y^2 + (z-b)^2}$ .

**Theorem 3.** a) If  $b > a$ , then the axis  $Oy$  is a non-constant field line.

b) If  $b > a, ab > 0$  then the axis  $Oy$  consists of two equilibrium points and three non-constant field lines.

c) If  $b > a, ab < 0$  (i.e.,  $a < 0, b > 0$ ), then the negative semiaxis  $Oy'$  of the axis  $Oy$  is a non-constant field line.

*Proof.* At the points of the axis  $Oy : \begin{cases} x = 0 \\ z = 0 \end{cases}$ , we have

$$r_1 = r_2 = \sqrt{y^2 + a^2 + b^2}$$

and

$$\left. \frac{dx}{dt} \right|_{Oy} = H_x|_{Oy} = 0, \quad \left. \frac{dz}{dt} \right|_{Oy} = H_z|_{Oy} = 0.$$

Also we have,

$$H_y|_{Oy} = \frac{2a}{r_1(r_1 - b)} - \frac{2b}{r_1(r_1 + a)},$$

and the following subcases occur:

a) If  $b < a$ , then  $H_y|_{Oy} > 0$ .

b) If  $b > a$ , then  $H_y|_{Oy} = 0$  implies  $r_1 = \frac{a^2 + b^2}{a - b}$ , and hence

$$y_{1,2} = \pm \frac{\sqrt{2ab(a^2 + b^2)}}{b - a}, \text{ pentru } ab > 0.$$

The points  $E_i(0, y_i, 0), i = 1, 2$  are stationary points. The open segment  $E_1E_2$ ) is a field line and  $H_y|_{E_1E_2} > 0$ . The semi-lines

$$\{0\} \times (-\infty, y_1) \times \{0\}, \quad \{0\} \times (y_2, \infty) \times \{0\}$$

are field lines and  $H_y$  is negative on them.

c) If  $a < b, ab < 0$ , then  $H_y|_{Oy} < 0$ .

2) There exist sets of at least two non-coplanar configurations, which are piecewise rectilinear, and which have open field lines. For example, the configuration in Fig.18, consisting of two pairs of rectilinear wires which are located in parallel planes  $z = a$  and  $z = -a$  traversed by opposed electric currents, have the magnetic field

$$\vec{H} = \left( \frac{-\bar{z}}{x^2 + \bar{z}^2} + \frac{\bar{z}}{x^2 + \bar{z}^2}, \quad \frac{\bar{z}}{y^2 + \bar{z}^2} - \frac{\bar{z}}{y^2 + \bar{z}^2}, \quad \frac{-y}{y^2 + \bar{z}^2} - \frac{y}{y^2 + \bar{z}^2} + \frac{x}{x^2 + \bar{z}^2} - \frac{x}{x^2 + \bar{z}^2} \right).$$

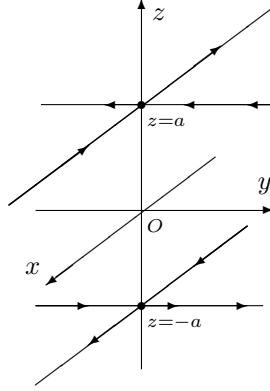

Fig. 18

This configuration admits as open field line the straight line

$$D : x + y = 0, \quad z = 0$$

indeed, we have

$$\bar{H}|_D = \left( \frac{2a}{x+a^2}, \quad -\frac{2a}{x+a^2}, \quad 0 \right),$$

and hence, the components of the field satisfy the relations

$$H_x|_D + H_y|_D = 0, \quad H_z|_D = 0.$$

Let  $\bar{H}$  be an irrotational magnetic field on  $D \subset \mathbb{R}^3$ ; let

$$f = \frac{1}{2}(H_x^2 + H_y^2 + H_z^2),$$

be the energy of the field  $\bar{H}$  and the Hamiltonian

$$\mathcal{H}(x, y, z, \frac{dx}{dt}, \frac{dy}{dt}, \frac{dz}{dt}) = \frac{1}{2} \left( \left( \frac{dx}{dt} \right)^2 + \left( \frac{dy}{dt} \right)^2 + \left( \frac{dz}{dt} \right)^2 \right) - f(x, y, z).$$

Then any magnetic line is the trajectory of a conservative dynamical system with three degrees of freedom

$$(5.1) \quad \frac{d^2x}{dt^2} = \frac{\partial f}{\partial x}, \quad \frac{d^2y}{dt^2} = \frac{\partial f}{\partial y}, \quad \frac{d^2z}{dt^2} = \frac{\partial f}{\partial z}$$

and the following Theorems 3 and 4 hold true.

**Theorem 4** [10]. *Each trajectory of the dynamical system (3) which has the total energy  $\mathcal{H}$  is a re-parametrized geodesic of the Riemann-Jacobi manifold*

$$(D \setminus Z_{\bar{H}}, g_{ij} = (\mathcal{H} + f)\delta_{ij}, i, j = 1, 2, 3),$$

where  $Z_{\bar{H}} = \{M \in D \mid \bar{H}(M) = \bar{0}\}$ .

A *ruled surface* in a Riemannian manifold  $(M, g)$  is a surface generated by a geodesic which moves along a curve  $\beta$ . Different positions of the generating geodesic  $\alpha$  are called *generators* of the surface. A ruled surface admits always a parametrization of the form

$$r : I \times [0, 1] \rightarrow M,$$

where  $r(u, v_o) = \beta(u)$  is the director curve and  $r(u_o, v) = \gamma(v)$  is a geodesic.

**Theorem 5** [18] 1) *The magnetic surfaces are ruled surfaces in the Riemann-Jacobi manifold  $(D \setminus Z_{\bar{H}}, g_{ij})$ .*

2) *The Gauss curvature  $K$  of a magnetic surface cannot be strictly positive.*

In  $D$  we shall use a cylindric system of coordinates  $\{\rho, \theta, z\}$ . Let  $\bar{H}$  be a magnetic field on  $D$ . The field  $\bar{H}$  admits the following symmetries

- 1) translational, iff  $\bar{H} = \bar{H}(\rho, \theta)$ ;
- 2) axial, iff  $\bar{H} = \bar{H}(\rho, z)$ ;
- 3) helicoidal, iff  $\bar{H} = \bar{H}(\rho, \theta - \alpha z)$ ,

where  $\alpha = \frac{2\pi}{L}$ , and  $L$  is the step of the helix.

Let  $\{\bar{e}_\rho, \bar{e}_\theta, \bar{e}_z\}$  the cylindric orthonormal frame and

$$\bar{H} = H_\rho \bar{e}_\rho + H_\theta \bar{e}_\theta + H_z \bar{e}_z.$$

The symmetric differential system which describes the field lines of  $\bar{H}$  rewrites

$$\frac{d\rho}{H_\rho} = \frac{\rho d\theta}{H_\theta} = \frac{dz}{H_z}.$$

The components of  $\bar{H}$  are related to the components of the vector potential

$$\bar{A} = A_\rho \bar{e}_\rho + A_\theta \bar{e}_\theta + A_z \bar{e}_z$$

by the relations

$$H_\rho = \frac{1}{\rho} \frac{\partial A_z}{\partial \theta} - \frac{\partial A_\theta}{\partial z}, H_\theta = \frac{\partial A_r}{\partial z} - \frac{\partial A_z}{\partial r}, H_z = \frac{1}{\rho} \frac{\partial}{\partial \rho}(\rho A_\theta) - \frac{1}{\rho} \frac{\partial A_\rho}{\partial \theta}.$$

Therefore, considering the existing symmetries we can find first integrals of the system (4).

**Theorem 6** [1]. 1) *If  $\bar{H}$  admits translational symmetry, then  $A_z(\rho, \theta)$  is a first integral, i.e., the surfaces given by*

$$A_z(\rho, \theta) = c$$

*are field surfaces.*

2) *If  $\bar{H}$  admits axial symmetry, then  $\rho A_\theta(\rho, z)$  is a first integral, i.e., the surfaces given by*

$$\rho A_\theta(\rho, z) = c$$

*are field surfaces.*

3) If  $\bar{H}$  admits helicoidal symmetry, then

$$A_z(\rho, \theta - \alpha z) + \alpha \rho A_\theta(\rho, \theta - \alpha z)$$

is a first integral, i.e., the surfaces given by

$$A_z(\rho, \theta - \alpha z) + \alpha \rho A_\theta(\rho, \theta - \alpha z) = c$$

are field surfaces.

The field surfaces (magnetic surfaces) of the previous theorem have the same symmetries as the field  $\bar{H}$ . Among these, only the field surfaces which have axial symmetry can be bounded. Also, if known a first integral of the system (4), the second first integral can be determined also.

## 6 Phase portraits

Let  $\beta : I \rightarrow \mathbb{R}^3$  be a simple curve, which is regular and transversal to the magnetic lines, and  $\alpha : I \rightarrow \mathbb{R}^3$  the magnetic line which passes through  $P \in \mathbb{R}^3$ . A magnetic surface  $\Sigma = \text{Im } r$  which is lining on the curve  $\beta$ , can be described by the parametrization  $r : D \subset \mathbb{R}^2 \rightarrow \mathbb{R}^3$ ,

$$r(u, v) = \alpha_{\beta(u)}(v), \forall (u, v) \in D \equiv \{(u, v) \in \mathbb{R}^2 \mid u \in I, v \in J_{\beta(u)}\}.$$

In the following, we shall represent certain magnetic lines and surfaces associated to the magnetic field  $\bar{H}$ . The field surfaces appear as a mesh

$$\Sigma \equiv \Sigma_{\mathcal{F}, H} = \{P_{ij} \mid i = \overline{0, m}, j = \overline{1, n}\},$$

where  $\mathcal{F} = \{P_{0j} \mid j = \overline{1, n}\}$  are equidistant points which belong to a segment  $\text{Im } \alpha$ , where

$$P_{0j} = \alpha(t_j), t_j = j \cdot l / (n - 1), j = \overline{0, n - 1}, I = [0, l],$$

and the grid points of the surface  $\Sigma$ ,

$$\{P_{ij} \mid i = \overline{0, m}, j = \overline{1, n}\}$$

are located on  $n$  field lines  $\text{Im } \alpha_{P_{0j}}, j = \overline{1, n}$ , which appear as a result of the numerical integration of the Cauchy problems

$$\begin{cases} \alpha'_{P_{0j}}(t) = \bar{H}(\alpha_{P_0}(t)) \\ \alpha_{P_{0j}}(0) = P_{0j}, j = \overline{1, n}. \end{cases}$$

The numerical integration is done using the method Runge-Kutta of order four; the initial time is  $t_0 = 0$  and the number of steps is  $m \geq 1$ .

The software package SURFIELD which describes locally a magnetic line or surface is designed in the C programming language, and is optimized for speed and allocated memory.



The 3D-objects can be translated, rotated and scaled. The magnetic curves  $\alpha$  and surfaces  $\Sigma$  are represented by central (perspective) projection.

The study of the shape of different magnetic surfaces  $\Sigma$  associated to the piecewise rectilinear nets, provides valuable experimental hints for the study of:

- the space displacement of the magnetic lines and surfaces,
- the localization of the fractal indecision zone, for close trajectories which enter different magnetic traps.

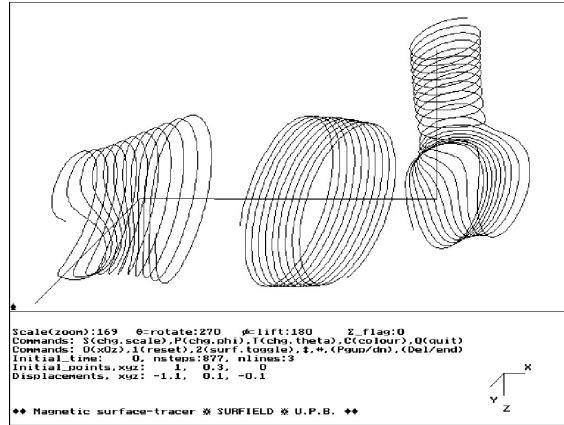

Fig. 19

In this context, of considerable interest is the evolution of magnetic field lines for a special configuration ("deformed U", [3], [4], see Fig. 19), whose magnetic lines appear to be open, and which is given by  $\Gamma = \Gamma_1 \cup \Gamma_2$ , where

$$\Gamma_1 = \gamma(A, \theta_+ = \frac{\pi}{2}, \varphi_+ = 0) \cup \gamma(A, \theta_- = 0, \varphi_- = 0)$$

$$\Gamma_2 = \gamma(B, \bar{\theta} = \theta, \bar{\varphi} = \varphi) \cup \gamma(B, \bar{\theta}' = \frac{\pi}{2}, \varphi' = 0)$$

with the vertices  $A(0, -1, 0), B(0, 1, 0) \in O_y, \varphi \neq 0$ .

An example of such a magnetic line is plotted below (see Fig. 20).

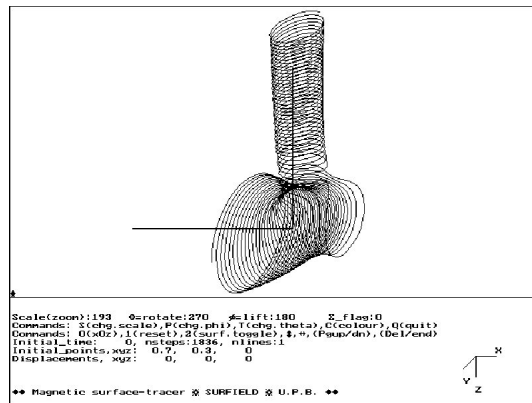

Fig. 20

**Conclusions.** The magnetic field and its vector and scalar potentials were determined for spatial piecewise rectilinear configurations. Classical planar and spatial particular cases were pointed out, and examples of configurations which generate open magnetic lines were provided. In this context, computer-drawn magnetic lines associated to the classical "deformed U" configuration ([3], [4]) were included.

## References

- [1] A.I.Morozov, L.S.Soloviev, The structure of magnetic fields, Reviews of Plasma Physics, vol.2, (1966), 1-101, Consultants Bureau, New-York.
- [2] E.Petrișor, Heteroclinic connections in the dynamics of a reversible magnetic-type vector-field, Physica D, 112(1998), 319-327.
- [3] M.Postolache, Al.Dragomir, Graphic Kernel for PC Computers, Proc. Nat. Conf. B.E.B. & F.E.M., Vol.4, pp.59-65, Sibiu, 1993.
- [4] M.Postolache, S.Udriște, Computer experiments for conformal dynamical systems, Workshop on Global Analysis, Diff.Geom. and Lie Algebras, Aristotle University of Thessaloniki, Dec. 16-18, 1993.
- [5] Sabba S.Ștefănescu, Addenda 1987 - Open Magnetic Field Lines, Rev. Roum. Geol. Geogr., 31(1987).
- [6] Sabba S.Ștefănescu, Lignes  $H$ , Circuits Rectilignes Coutes, Manuscript Notices, 1944-1992, unpublished.
- [7] Sabba S.Ștefănescu, C.Udriște, Magnetic Field Lines around Filiform Electrical Circuits of Right Angle Type, Int. Conf. Diff. Geom. Appl., August 24-29, 1992, Bucharest, Scientific Bulletin, Applied Mathematics and Physics, Series A, 55(1993), 3-18, Politehnica University of Bucharest.
- [8] A.Udriște, Geometric properties of magnetic field lines around two filiform electrical circuits of right angle type, Poster at The First European Congress of Math., Paris, July 6-10, 1992.
- [9] A.Udriște, C.Udriște, Dynamics induced by a magnetic field, Conference on Differential Geometry, Budapest, July 27-30, 1996; In: Ed. J.Szente, New Developments in Differential Geometry, Kluwer Academic Publishers (1996), 429-442.
- [10] C.Udriște, Convex functions and optimization methods on Riemannian manifolds, 297, Kluwer Academic Publishers, 1994.
- [11] C.Udriște, Geometric dynamics, Second Conference of Balkan Society of Geometers, Aristotle University of Thessaloniki, June 23-26, 1998.
- [12] C.Udriște, M.Postolache, T.Mazilu, A.Udriște, Equilibrium Positions of Magnetic Field Generated by Currents through Filiform Electrical Circuits of Right Angle Type, Int.Symp.Appl.Math.Mech., Sept. 2-6, 1992, Cluj-Napoca; in: Ed. Grigorios Tsagas, BSG Proceedings 2, Global Analysis, Differential Geometry, Lie Algebras, Geometry Balkan Press (1998), 125-136.

- [13] C.Udriște, M.Postolache, A.Udriște, "Acad. Sabba S.Ștefănescu Conjecture; Lines of Magnetic Field Generated by Filiform Electrical Circuits", *Revue Roumaine Geophysique, Romanian Academy*, 36 (1992), 17-25.
- [14] C.Udriște, M.Postolache, A.Udriște, Energy of Magnetic Field Generated by Filiform Electrical Circuits of Right Angle Type, *Proc. Int. Conf. Diff. Geom. Appl.*, August 24-29, 1992, Bucharest, *Tensor N.S.*, 54(1993), 185-195.
- [15] C.Udriște, M.Postolache, A.Udriște, Numerical Simulation of Dynamic Magnetical System, *Third Int.Symposium "Chaotic Dynamical Systems"*, Utrecht, The Netherlands, June 14-17, 1992, *Scientific Bulletin, Applied Mathematics and Physics, Series A*, 55(1993), 51-64, *Politehnica University of Bucharest*.
- [16] C.Udriște, C.Radu, C.Dumitrescu, A.Zlatescu, *Integrales Biot-Savart-Laplace*, *Proceedings of Int.Conf.Diff.Geom.Appl.*, Bucharest, August 24-29, 1992, *Tensor N.S.* 53(1993), 196-202.
- [17] C.Udriște, A.Udriște, *Electromagnetic dynamical systems*, *Balkan Journal of Geometry and Its Applications*, v.2, n.1(1997), 129-140.
- [18] C.Udriște, A.Udriște, *Properties of the magnetic lines and surfaces*, *Proceedings of 23-rd Conference on Geometry and Topology*, Sept 27-29, 1993, 203-208, *Babes-Bolyai University, Cluj-Napoca*.
- [19] C.Udriște, A.Udriște, V.Balan, M.Postolache, *Equilibrium points of Magnetic Fields Generated Around Filiform Electrical Circuits*, *Tensor N.S.*, vol.57, no.2(1996), 119-134.
- [20] C.Udriște, A.Udriște, V.Balan, M.Postolache, *Magnetic Dynamical Systems*, *An. St. Univ. "Al. I. Cuza" Iași, Tom IV, Informatică*, 1995, pp. 105-126.
- [21] C.Udriște, A.Udriște, V.Balan, M.Postolache, *Magnetic Dynamical Systems (II)*, *Proc. of the Colloquium on Diff.Geom.*, Debrecen, July 26-30, 1994, "New Developments in Differential Geometry" - editors: L.Tamassy and J.Szenthe, *Kluwer Acad. Publishers*, 1996, pp. 407-414.
- [22] C.Udriște, A.Udriște, V.Balan, M.Postolache, *Magnetic Field Generated by Two Coplanar Electrical Circuits of Fixed Angle Type and Its Field Lines*, *Proc. of the 24-th National Conference of Geometry and Topology*, Timișoara, 1994, *Ed.Mirton, Timișoara*, 1996, pp.285-301.
- [23] C.Udriște, A.Udriște, V.Balan, M.Postolache, *Phase Portraits and Critical Elements of Magnetic Fields Generated by Piecewise Rectilinear Electrical Circuits*, in "Lagrange and Finsler Geometry" editors: P.L.Antonelli and R.Miron, *Kluwer Acad. Publishers*, 1996, 177-187.
- [24] C.Udriște, A.Udriște, C.Dumitrescu, T.Vasile, *Geometry of magnetic flow*, *Proceedings of International Workshop on Diff.Geom.Appl.*, Bucharest, July 25-30, 1993, *Scientific Bulletin, Applied Mathematics and Physics*, 55, 3-4 (1993), 279-283, *Politehnica University of Bucharest*.

- [25] C.Udriște, S.Udriște, Biot-Savart-Laplace dynamical systems, *Balkan Journal of Geometry and Its Applications*, v.1, n.2(1996), 125-136.
- [26] C.Udriște, S.Udriște, Magnetic field generated by electrical circuits seated on a pair of coplanar isosceles triangles, XXV-th Session of Scientific Communications of Military Technical Academy, Bucharest, June 10-11, 1993.
- [27] S.Udriște, Magnetic field generated by electrical circuits seated on a pair of coplanar isosceles, *Scientific Bulletin, Electrical Engineering, Politehnica University of Bucharest*, 55, 3-4 (1993),69-74.

Authors' address:

Constantin Udriște, Vladimir Balan and Aneta Udriște  
Politehnica University of Bucharest, Department Mathematics I,  
Splaiul Independenței 313, RO-77206 Bucharest, Romania.  
E-mail: udriste@mathem.pub.ro, vbalan@mathem.pub.ro